

Name: _____

Advisor: _____

Preparatory Courses
 (Either at College or the equivalent preparations at High School)

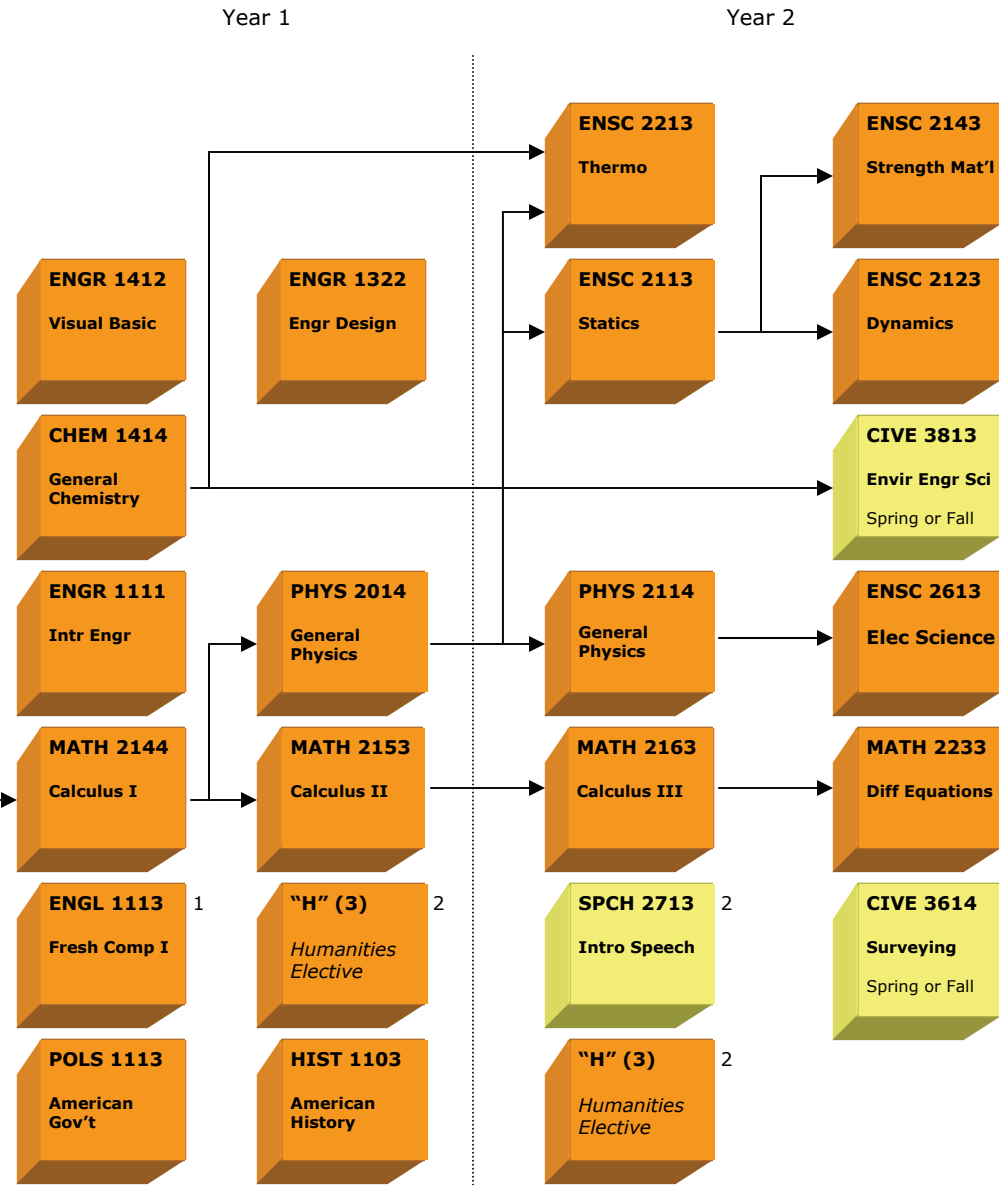
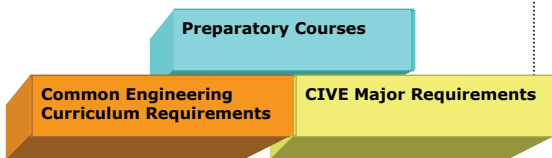
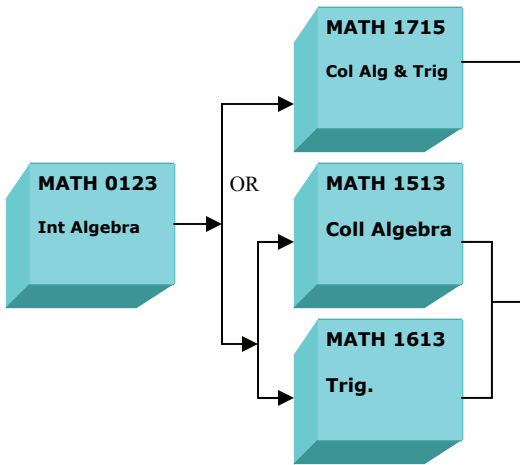

Admission to Professional School is required to take the upper level CIVE courses.

Please refer to the OSU Catalog corresponding to your matriculation date for detailed admission requirements. The following is an overview of the minimum curricular requirements necessary to be considered for admission to the CIVE Professional School:

- Completion of MATH 2144, 2153, 2163, and 2233; PHYS 2014 and 2114; CHEM 1414; ENGR 1111 and 1412; ENSC 2113, 2143, plus two additional ENSC courses ; ENGL 1113, and if required, ENGL 1213.
- A grade of "C" or better is required in all math, science and engineering courses used to satisfy a requirement in the civil engineering degree plan prior to admission to professional school.
- At least 12 credit hours of courses required for the degree must be completed at OSU, with a grade-point average of 2.5 or higher in these courses. This must include at least 9 hours of technical subjects with a GPA of 2.5 or higher.
- An overall GPA of 2.3 or better at OSU is required.

NOTE: This flow chart is for planning purposes only. Students matriculating in 2011 must meet the degree requirements as stated on the official degree requirement sheet dated "Academic Year 2011-2012."

1. Students with less than a "B" in ENGL 1113 or 1313 must take ENGL 1213 or 1413; **in addition to ENGL 3323.**
 2. At least 6 hours designated "H" and at least 6 hours designated "S". Civil students must select SPCH 2713 plus 3 hrs designated "S". Of the courses chosen to meet the "H" and "S", students must also meet the Diversity "D" and International Dimension "I" requirement.

Name: _____

Year 3

Year 4

Advisor: _____

PREREQUISITES

CIVE 3614

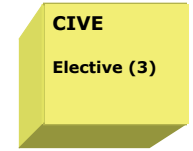
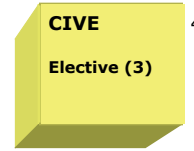
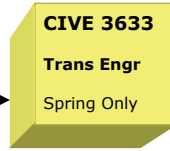

ENSC 2113, 2143

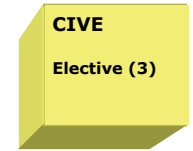
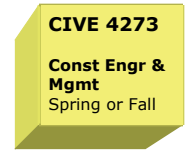
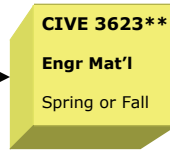
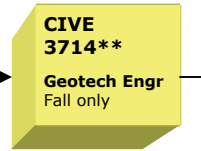

MATH 2153

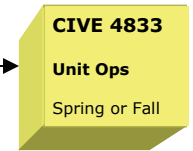
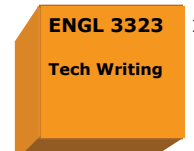
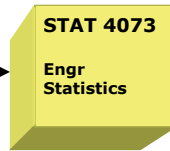

MATH 2163

ENSC 2113, 2143

CIVE 3813, ENSC 3233

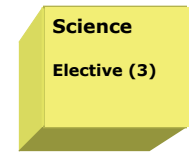
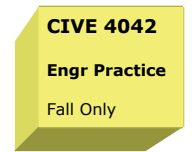
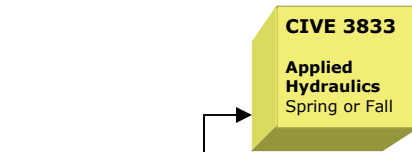
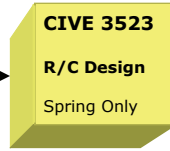
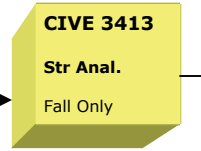

CHEM 1414, PHYS 2014, ENSC 2113

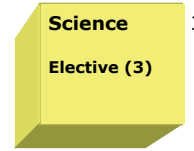
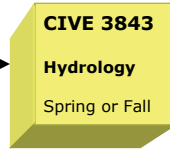
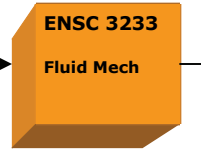

Master's Programs

Criteria for admission to the Graduate College to pursue the Master of Science or Master of Civil Engineering include:

1. Receive a B.S. degree from an accredited institution (the Bachelor of Science degree or certification in an accredited engineering program is required for the Master of Civil Engineering degree).
2. Academic performance in undergraduate work at a level that indicates a high probability of success in a graduate program requiring a 3.0/4.0 minimum grade point average.
3. Recommended for admission to the Graduate College by a Professional School in the College of Engineering.

For further information, contact the School or the Office of the Dean of Engineering

A flexible study plan is designed to meet each student's individual goals.

3. BIOL 1114; CHEM 2113, 3053; GEOG 2343; GEOL 1114, 4453; PHY 3013, 3313, 3513; SOIL 2124; MATH 3013, 4013, 4233.
 4. 9 hours of 4000- or 5000-level courses in Civil Engineering not required in the curriculum.
 5. Is satisfied by CIVE 4043 or CIVE 4143 or CIVE 5373 or CIVE 5383.

• ** CIVE 3714 must be taken prior to or simultaneously with CIVE 3623
 • A "C" or better is required in each course that is a prerequisite for a major course.